

-  Loctite 271
-  Perfect Seal Sealing Compound No.4
-  Loctite 680
-  Chemtool Duralube Special

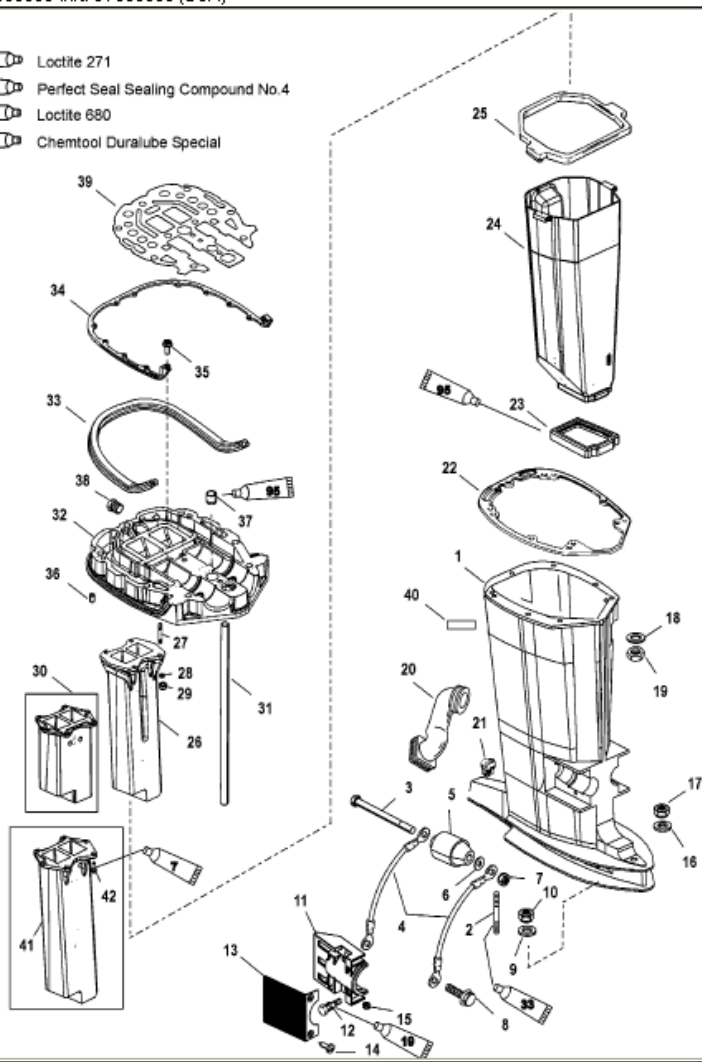

1104

Parts List						
Ref	Class	Part	Description	Qty	Comment	Footnote
1	1590	8343T10	DRIVE SHAFT HOUSING	1	(LONG)	
1	3503	813563T 1	DRIVE SHAFT HOUSING	1	(X-LONG)	
2	16	56295	STUD	2		
3	10	63474	SCREW (1/2-20 x 6 IN.)	2		
4		88238A10	GROUND WIRE	2		
5		77327	LOWER MOUNT	2		
6	12	49339	WASHER	2		
7	11	826708 17	NUT	2		
8	10	41508	SCREW (1/4-20 x 3/8 IN.)	1		
9	12	45176	WASHER	2		
10	11	34933	NUT	2		
11	54	67076	CLAMP	2		
12	10	66727	SCREW (5/16-18 x 1-1/4 IN.)	4		
13		67077T	COVER	2		
14	10	88417	SCREW (12-24 x 5/8 IN.)	4		
15	11	35521	NUT	4		
16	12	48926	WASHER	1		
17	11	34933	NUT	1		
18	12	20553	WASHER	4		
19	11	69254	NUT	4		
20		828212	IDLE EXHAUST BOOT	1		
21	19	64649	PLUG	1		
22	27	99173 4	GASKET	1		2
23		66350	SEAL (LOWER)	1		
24		18276	EXHAUST TUBE	1		
25		17726 1	SEAL (UPPER)	1		
26		812834A 2	EXHAUST EXTENSION	1	(150/175)(STUD MOUNTING	
27	16	883085	STUD	4		
28	12	35044	WASHER	4		
29	11	888500	NUT	4		
30		41942 4	EXHAUST EXTENSION	1	(200)	
31	32	859097 1	WATER TUBE	1	(LONG)	
31	32	859097 2	WATER TUBE	1	(X-LONG)	
32		18233A 8	DRIVE SHAFT HOUSING PLATE	1	(WITHOUT TWO HOLES IN THE	
32		18233A20	DRIVE SHAFT HOUSING PLATE	1	(WITH TWO HOLES IN THE BAC 1	
33		814701 2	SEAL	1		
34		68011	BRACKET	1		
35	10	878608	SCREW (10-x1/2 IN.)	12		
36	17	43044	DOWEL PIN	2		
37	26	38970	SEAL	1		2
38	22	22802 2	PIPE PLUG	2		